

How Anyone  
or Any Church  
can Understand  
and Follow  
What God Wants  
Us to Be...



## Introduction

Ac 17:22

¶ And Paul stood in the midst of the Areopagus, and said, Ye men of Athens, in all things, I perceive that ye are very religious.

Acts 18:25-26

This man had been instructed in the way of the Lord; and being fervent in spirit, he spake and taught accurately the things concerning Jesus, knowing only the baptism of John: and he began to speak boldly in the synagogue. But when Priscilla and Aquila heard him, they took him unto them, and expounded unto him the way of God more accurately.

1 Corinthians 1:11-13

For it hath been signified unto me concerning you, my brethren, by them that are of the household of Chloe, that there are contentions among you. Now this I mean, that each one of you saith, I am of Paul; and I of Apollos: and I of Cephas; and I of Christ. Is Christ divided? was Paul crucified for you? or were ye baptized into the name of Paul?

## **This We All Believe...**

Romans 3:4

God forbid: yea, let God be true, but every man a liar; as it is written, That thou mightest be justified in thy sayings, and mightest overcome when thou art judged.

John 17:17

Sanctify them through thy truth: thy word is truth.

1 John 2:15-17

Love not the world, neither the things that are in the world. If any man love the world, the love of the Father is not in him. For all that is in the world, the lust of the flesh and the lust of the eyes and the vain glory of life, is not of the Father, but is of the world. And the world passeth away, and the lust thereof: but he that doeth the will of God abideth for ever.

## What Can We Do...

2Ti 2:15

Study to shew thyself approved unto God, a workman that needeth not to be ashamed, rightly dividing the word of truth.

Acts 17:10-11

And the brethren immediately sent away Paul and Silas by night unto Berea: who when they were come thither went into the synagogue of the Jews. Now these were more noble than those in Thessalonica, in that they received the word with all readiness of the mind, examining the Scriptures daily, whether these things were so.



- + Methodist Discipline = Methodist Christian
- + Catechism = Roman Catholic Christian
- + Westminster Confession = Presbyterian Christian
- + 39 Articles of Faith = Episcopalian Christian
- + Book of Mormon = Mormon Christian
- + Nothing - Nothing = Christian

Revelation 22:18-19

I testify unto every man that heareth the words of the prophecy of this book, if any man shall add unto them, God shall add unto him the plagues which are written in this book: and if any man shall take away from the words of the book of this prophecy, God shall take away his part from the tree of life, and out of the holy city, which are written in this book.

James 1:23-24

For if any one is a hearer of the word and not a doer, he is like unto a man beholding his natural face in a mirror: for he beholdeth himself, and goeth away, and straightway forgetteth what manner of man he was.

## Secular Organisation

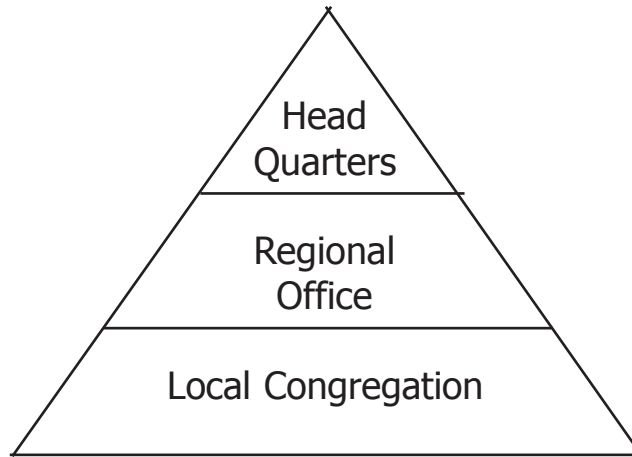

## vs Scriptural Organisation

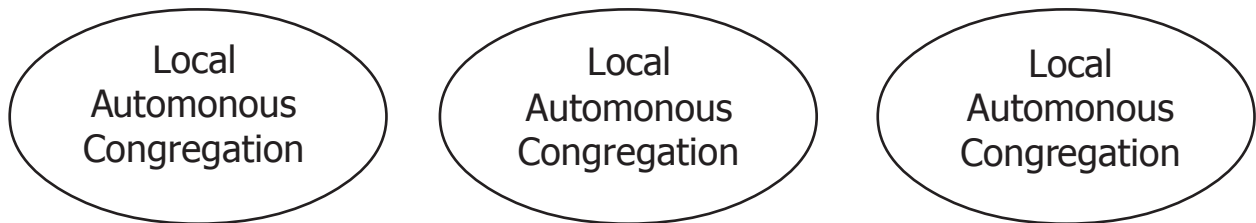

Titus 1:5

For this cause left I thee in Crete, that thou shouldest set in order the things that are wanting, and ordain elders in every city, as I had appointed thee:

Acts 20:28-30

Take heed unto yourselves, and to all the flock, in which the Holy Spirit hath made you bishops, to feed the church of the Lord which he purchased with his own blood. I know that after my departing grievous wolves shall enter in among you, not sparing the flock; and from among your own selves shall men arise, speaking perverse things, to draw away the disciples after them.

1 Peter 5:4

And when the chief Shepherd shall appear, ye shall receive a crown of glory that fadeth not away.

## Which Church Will Be Saved?

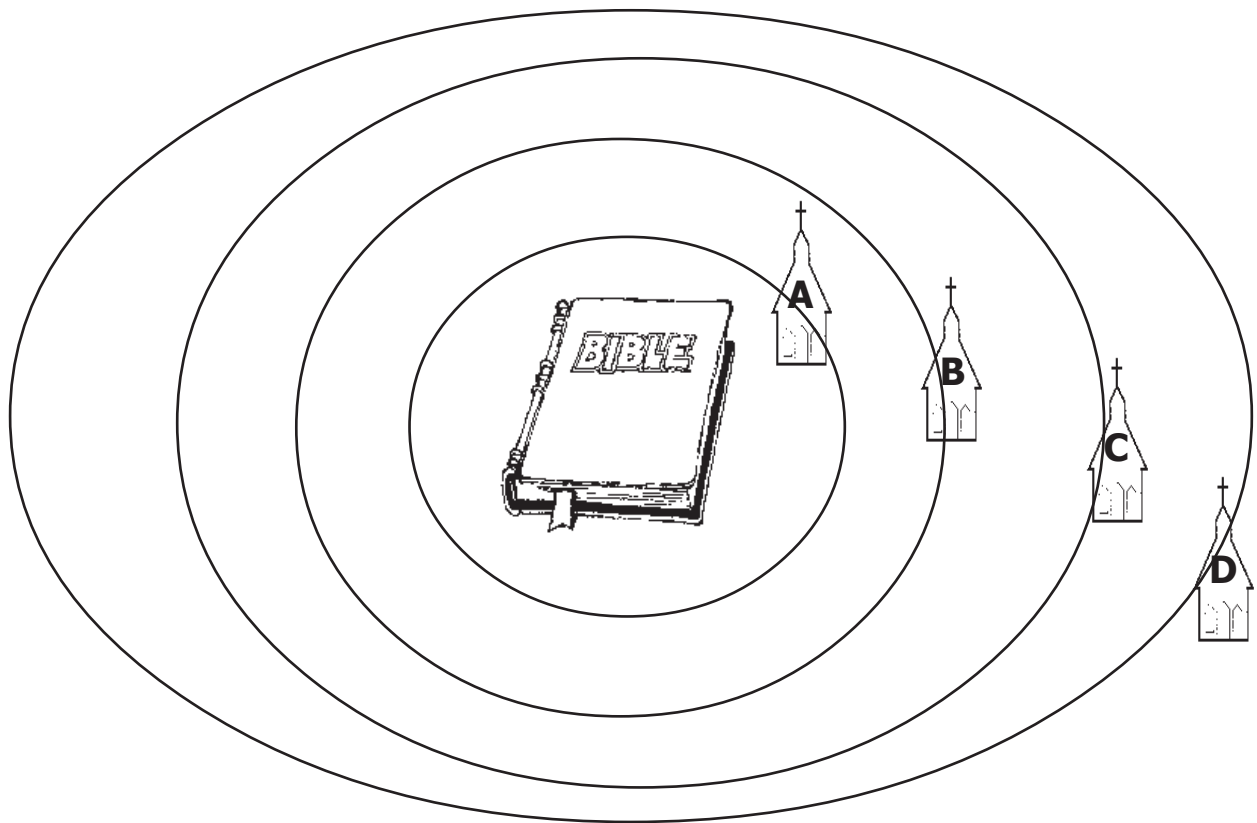

Matthew 7:21-23

Not every one that saith unto me, Lord, Lord, shall enter into the kingdom of heaven; but he that doeth the will of my Father who is in heaven. Many will say to me in that day, Lord, Lord, did we not prophesy by thy name, and by thy name cast out demons, and by thy name do many mighty works? And then will I profess unto them, I never knew you: depart from me, ye that work iniquity.

Matthew 15:13

But he answered and said, Every plant, which my heavenly Father hath not planted, shall be rooted up.

Ephesians 5:26

That he might sanctify and cleanse it with the washing of water by the word,

## Restore or Reform?

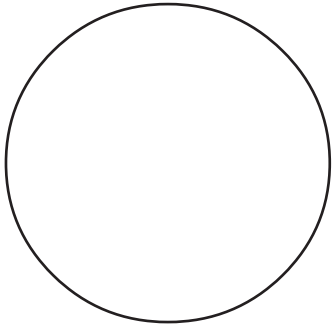

**Original**

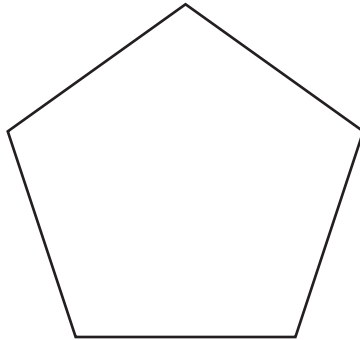

**Deform**

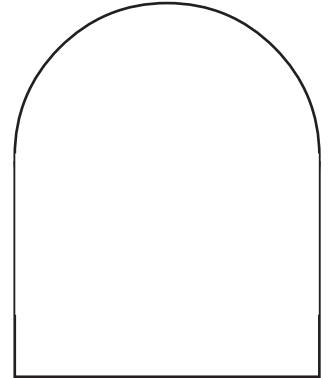

**Reform**

Genesis 6:22

Thus did Noah; according to all that God commanded him, so did he.

Exodus 25:9

According to all that I shew thee, after the pattern of the tabernacle, and the pattern of all the instruments thereof, even so shall ye make it.

Matthew 15:9

But in vain they do worship me, teaching for doctrines the commandments of men.

## Is Christ's Prayer Possible?



John 17:20-23

Neither for these only do I pray, but for them also that believe on me through their word; that they may all be one; even as thou, Father, art in me, and I in thee, that they also may be in us: that the world may believe that thou didst send me. And the glory which thou hast given me I have given unto them; that they may be one, even as we are one; I in them, and thou in me, that they may be perfected into one; that the world may know that thou didst send me, and lovedst them, even as thou lovedst me.

Matthew 18:3

And said, Verily I say unto you, Except ye be converted, and become as little children, ye shall not enter into the kingdom of heaven.

## How We Can All Agree...

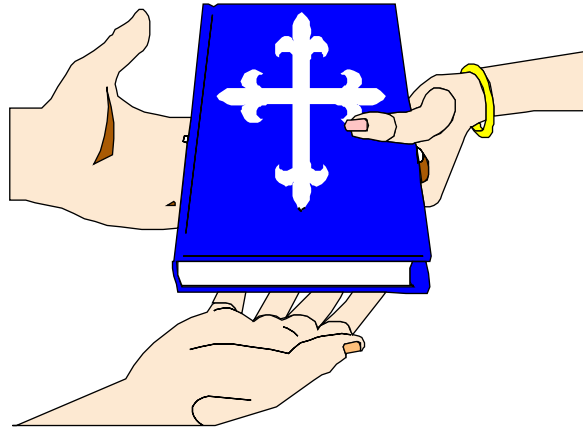

### **1. No compromise: Matters pertaining to salvation**

1 Timothy 4:16

Take heed unto thyself, and unto the doctrine; continue in them: for in doing this thou shalt both save thyself, and them that hear thee.

### **2. Study: Matters not pertaining to salvation**

Isaiah 1:18

Come now, and let us reason together, saith the LORD: though your sins be as scarlet, they shall be as white as snow; though they be red like crimson, they shall be as wool.

### **3. Cultural Traditions**

1 Corinthians 11:16

But if any man seemeth to be contentious, we have no such custom, neither the churches of God.

### **4. Matters of Opinion**

Romans 14:4-6

Who art thou that judgest the servant of another? to his own lord he standeth or falleth. Yea, he shall be made to stand; for the Lord hath power to make him stand. One man esteemeth one day above another: another esteemeth every day alike. Let each man be fully assured in his own mind. He that regardeth the day, regardeth it unto the Lord: and he that eateth, eateth unto the Lord, for he giveth God thanks; and he that eateth not, unto the Lord he eateth not, and giveth God thanks.

**Conclusion:**

# Do You or Your Church want to Understand and Follow What God Wants Us to Be?

Revelation 2:29

He that hath an ear, let him hear what the Spirit saith unto the churches.

Matthew 18:3

And said, Verily I say unto you, Except ye be converted, and become as little children, ye shall not enter into the kingdom of heaven.

James 1:23-25

For if any one is a hearer of the word and not a doer, he is like unto a man beholding his natural face in a mirror: for he beholdeth himself, and goeth away, and straightway forgetteth what manner of man he was. But he that looketh into the perfect law, the law of liberty, and so continueth, being not a hearer that forgetteth but a doer that worketh, this man shall be blessed in his doing.

## Discussion:



1. Your discussion leader will summarise the lesson in his own words
  - a) Feel free to ask any questions
  - b) Share with us any suggestions that you may have
  
2. Your discussion leader will share of his experience in learning and becoming what God wants him to become
  - a) We encourage you to share your personal experiences as well
  
3. On the next page are two examples of coming to an understanding of what the Bible teaches
  - a) Go through each and see if you agree
  - b) Share your comments

## **Application A - Plan of Salvation**

Much confusion is seen among the religious world regarding the matter of salvation. How much can one be sure – really sure? Just as a man is certain he is not lost if he holds the street map on his hand and fixes his eyes on the street sign; a person can be sure regarding the state of his souls if he holds the Bible and fixes his eyes on his response to it. So, let us go to the Bible – God’s word for the answer

In the Bible, we see 3 places where men asked this question about their salvation and received inspired answers. Let us turn to God’s word and read if for ourselves.

Acts 2:37 – Question: What shall we do?  
Answer: Repent and be baptized (v.38)

Acts 16:30 – Question: What must I do to be saved?  
Answer: Believe (v.31)

Acts 22:10 – Question: What shall I do, Lord?  
Answer: Arise and be baptized. (v.16)

How is a person saved? Simply by believing, repenting and being baptized! Read also Rom 10:9-10, Eph 2:8-9, James 2:17 and Rev 2:10

This is what the Bible teaches about salvation. It is so simple, clear and easy to understand when we go to it personally.

## **Another Application – Instrumental Music in Worship**

Should we use instrumental music to worship God? Let us see what the Bible says. We see that instrumental music in worship is only used in the Old Testament and no command is given in the New Testament.

Romans 10:17 teaches that faith comes from hearing the word of God. Since we cannot worship God today using instrumental music by faith (since it not in the New Testament) it becomes sin (Rom 14:23).

Thus we understand why Cain’s offering was rejected (Gen 4:5.) You see, Heb 11:4 tells us Abel offered his sacrifice by faith (based on God’s word) while Cain did not – thus it was sinful. And God did not respect his sacrifice even though he may be sincere and have good intentions.